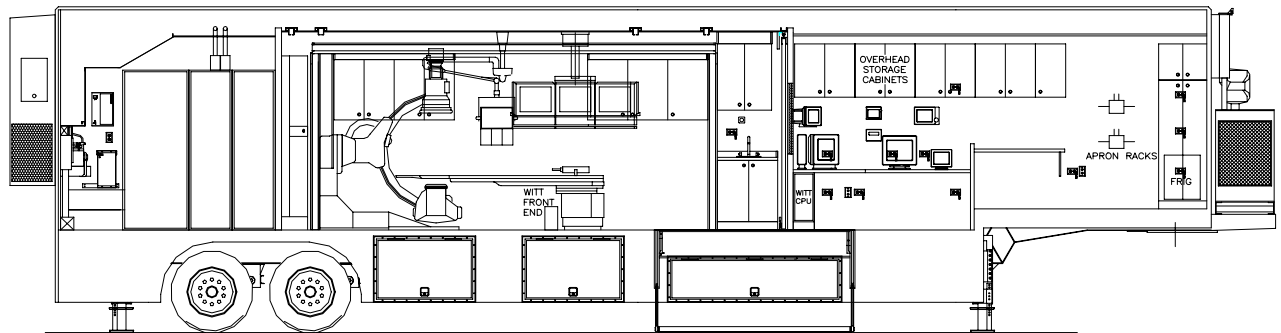




Site Planning Guide

GE ADVANTX Cardiac Catheterization Laboratory 48' L x 8'-6" W x 13'-6" H USA Unit



© 2007 Oshkosh Specialty Vehicles, All Rights Reserved

This guide contains confidential information of Oshkosh Specialty Vehicles. You may not copy it or any part of it without the written permission of Oshkosh Specialty Vehicles. This manual may be used only by you, and only for the purposes for which it was intended. You may not disclose this manual or the confidential information it contains outside your company. If you wish to copy part of this manual or to use it other than as described above, you must write to Oshkosh Specialty Vehicles seeking permission to do so.

North America

Corporate Headquarters
Oshkosh Specialty Vehicles
16745 South Lathrop Ave.
Harvey, IL
60426
USA
(001) 708.596.5066

Europe

Oshkosh Specialty Vehicles, Ltd.
Unit 17, Nelson Way
Tuscum Trading Estate,
Camberley, Surrey
GU15 3DH
United Kingdom
(44) 01276.64490

Buys Ballotstraat 6
3261 LA Oud-Beijerland, Holland
+31 (0) 186-614322
Fax. +31 (0) 186-619367
E-mail: smit@smit-mobile.nl

List of Revisions

<u>Revision</u>		<u>Date</u>
00	Initial Release	October-1999
03	Updated company information	November-2001
04	Updated Drawings, added Lockout/Tagout	October-2002
05	Updated stairs geometry & dimensional data	November-2002
06	Updated Drawings	January 2003
07	Added Radiation Shielding Requirement	July 2003
08	Updated Specifications	June 2004
09	Added A/C Clearance Requirement	August 2004
10	Patient to Platform	August-2006
11	Update Logo & Company Information	January 2007

Notice

In accordance with our policy of product development, Oshkosh Specialty Vehicles reserves the right to make changes in the equipment, design, specifications, and materials of the product described herein. If there are any inconsistencies between this manual and the mobile unit that inhibit serviceability, please contact Oshkosh Specialty Vehicles for assistance.

Any problems or questions related to the components or systems covered in this manual may be directed to:

Oshkosh Specialty Vehicles
16745 South Lathrop Avenue
Harvey, IL
60426
USA

(001) 800.839.0630 (24 hour service)
(001) 708.596.2480 (fax)

<http://www.oshkoshsv.com/>

Table of Contents

<u>Introduction</u>	5
Warnings & Safety Alert Conventions.....	5
<u>Support Pad Requirements</u>	6
Trailer Weight.....	6
Minimum Support Pad Requirements.....	6
Recommended Support Pad.....	6
Recommended Service Pad.....	6
Support Pad Depth.....	6
Support Pad Levelness.....	6
Vehicle Access.....	6
Recommended Attachment to the Facility.....	6
Swing Clearance Note.....	7
Air Conditioning Air Flow Clearance.....	7
<u>Radiation Shielding Requirements</u>	8
Radiation Shielding.....	8
<u>Customer Power Requirements</u>	9
Lockout/Tagout.....	9
Electrical Service.....	9
Frequency.....	9
Phase Balance.....	9
Maximum voltage variation.....	9
Connector Type.....	9
Customer Facility.....	10
Power Source Monitoring (Facility Only).....	10
<u>Mobile Grounding Requirements</u>	11
Ground Conductor.....	11
Special Grounding Note.....	11
Mobile Grounding Chart.....	12
<u>Telephone, Data and Emergency Connections</u>	13
Telephone Service.....	13
Data Service.....	13
Code Blue Connections.....	13
Fire Alarm Connections.....	13
<u>Water Requirements</u>	14
Humidifier Water Fill.....	14
Potable Water Supply Requirements.....	14
Waste Water Connections.....	14

Table of Figures

Figure 1: Pad Layout	15
Figure 2: Right Side Elevation	16
Figure 3: Left Side Elevation	17
Figure 4: Stair / Lift / Wall Elevation	18
Figure 5: Radiation Shielding Plan View	19
Figure 6: Russellstoll Service Outlet.....	20
Figure 7: Russellstoll Chart	21
Figure 8: Turning Requirements.....	22
Figure 9: Variations of Stair Arrangement	23
Figure 10: Code Blue and Fire Alarm Connections.....	24

Introduction

The purpose of this document is to provide the basic information needed for site planning. For specific information not contained in this document, please contact Oshkosh Specialty Vehicles.

The mobile unit requires sufficient room to be maneuvered and positioned for setup and takedown. The mobile unit has many storage compartments and service doors that require access during these procedures as well as during operation. The expanding wall sections, platform lift, entry stair and optional platform require additional space on the right side of the mobile unit. Refer to the drawings provided for actual locations of doors, platform lift, and stair sizes and locations.

Warnings & Safety Alert Conventions

Three types of statements are used throughout this document to warn the operator of potential situations. Always read these statements carefully and take the appropriate safety precautions to ensure a safe environment for all personnel and all property. The statements are as follows:



This type of notice indicates a potentially hazardous situation, which if not avoided, could result in injury or death to the operator of the mobile unit.



This type of notice indicates a potentially hazardous situation, which if not avoided, could result in irreparable damage to the mobile unit.



This type of notice is meant to inform the operator of useful information.

Support Pad Requirements

IMPORTANT

If other modalities utilize the same support pad, it is recommended that non-ferrous reinforcement materials be used for pad reinforcement.

IMPORTANT

GE must approve plans for pad construction.

The following is a list of recommendations and requirements for a concrete support pad. However, due to varying site conditions, the actual pad design should be prepared by an appropriately licensed structural or architectural engineer.

Trailer Weight

The weight of the trailer should be considered in the design of the support and service pads. The overall weight of the trailer is approximately 52,220 lbs. The weight on the rear axles is approximately 33,320 lbs. The weight on the King Pin is approximately 18,900 lbs.

Minimum Support Pad Requirements

A front pad measuring 9'-0" x 4'-0" and a rear pad measuring 9'-0" x 15'-0" located as shown on [Figure 1: Pad Layout](#), and [Figure 2: Right Side Elevation](#) will provide the minimum requirements. All cross-hatching represents the minimum support pad.

Recommended Support Pad

A full pad measuring 9'-0" x 40'-0", located as shown on [Figure 1: Pad Layout](#) and [Figure 2: Right Side Elevation](#) as the crosshatching, is the recommended support pad.

Recommended Service Pad

A full pad measuring 23'-11 5/8" x 55'-6", located as shown on [Figure 1: Pad Layout](#) and [Figure 2: Right Side Elevation](#) is recommended to provide a service access.

Support Pad Depth

Recommendations for the width and length of the pad are given above. Based upon the existing site conditions, the depth should be determined by a local contractor. It is recommended that non-ferrous reinforcement materials be used for pad reinforcement.

Support Pad Levelness

The support pad must be level to ensure proper operation of the medical system. The pad must not exceed .125" deviation in 10'-0". If the minimum support pads are selected, rather than the recommended single pad, they must also meet this specification.

Vehicle Access

A firm, level surface is required around the mobile unit in order to provide access to the site, patient access to the mobile unit, and servicing of the mobile unit.

Recommended Attachment to the Facility

An inflatable air bag or soft seal is recommended at the point of connection from the unit to the facility. Fixed or solid connections may hinder imaging quality. Contact Oshkosh Specialty Vehicles or the local GE representative prior to construction if the proposed connection varies from the recommended.

Swing Clearance Note

Please verify the actual dimensions of the rearmost projections on the cab of your tractor to the centerline of tandem suspension or centerline of the fifth wheel plate on your tractor. Refer to [Figure 8: Turning Requirements](#) for proper tractor sizing information.

Air Conditioning Air Flow Clearance

The following clearances for acceptable air conditioning condenser air flow have been established between wall-mounted equipment and opposing units or surfaces for maximum capacity, lowest operating cost, satisfactory operation of ventilation packages, and longest service life

Unit discharging against opposing (facing) unit – 20 feet from coil grill to coil grill

Unit discharging against a wall or essentially solid barrier – 15 feet from coil grill to wall. See [Figure 1: Pad Layout](#).

Radiation Shielding Requirements

Radiation Shielding

IMPORTANT

Radiation exposure limits must be in accordance with all local, state, and federal requirements. It is the responsibility of the customer to perform a proper radiation survey in order to determine the exclusion zone.

Care should be taken when determining a site location. Factors such as shielding design, proximity to buildings, and occupancy of the surrounding areas must be considered. An exclusion zone around the mobile unit may be necessary. Refer to [Figure 5: Radiation Shielding Plan View](#) for additional information.

Customer Power Requirements



It is the operator's responsibility to verify that the shore power receptacle is of the same type and voltage as the connection that is supplied by Oshkosh Specialty Vehicles. Failure to do this can result in injury or death to the operator of the mobile unit as well as irreparable damage to the mobile unit.



The standard connector for the unit is a Russellstoll DS2504MP000/DF2032 480V 200A Plug. If an existing site currently implements a different connector or connector configuration, please contact Oshkosh Specialty Vehicles in order to arrange for a compatible power connector before the unit leaves the facility.

Lockout/Tagout

A Lockout/Tagout provision in accordance with OSHA Standard 1910.147 is required. The facility shore power disconnect device must be located within 40'- 0" of the unit and must provide for an effective lockout/tagout to facilitate safe service and maintenance of the unit.

Electrical Service

480 Volt A.C., 3 Phase, 150 Amps

Three phase wye connection with neutral and ground.

The fused main disconnect requires 150 amp dual element time delay fuses, FRS-R150 or equivalent.

Frequency

60Hz \pm 0.5Hz maximum

Phase Balance

The phase balance is 2% max between phases

Maximum voltage variation

The maximum voltage variation is \pm 5% from nominal steady state (under the worst case conditions of line voltage)

Connector Type

The unit is supplied with a 35-foot (useable) cable and male connector. The connector is a Russellstoll 200 Amp plug DS2504MP000/DF2032. The facility must have the matching receptacle as specified in [Figure 6: Russellstoll Service Outlet](#) and [Figure 7: Russellstoll Chart](#). The receptacle is a Russellstoll DF2504FRAB0 female connector.

Customer Facility

The customer facility must have the matching receptacle as specified in [Figure 6: Russellstoll Service Outlet](#) and [Figure 7: Russellstoll Chart](#). Unless otherwise specified, the receptacle type to be used must be a Russellstoll female connector.

The unit is supplied with a 35' long cable and male connector for the **Fire Alarm** function. The connector is a [Russellstoll #SKWP8G](#). The facility must have the matching female receptacle [Russellstoll #SKWR8G](#) and weatherproof cover.

Power Source Monitoring (Facility Only)

NOTE: Perform a power audit first.

A power analyzer should be used to check the proposed Mobile Cardiac Catheterization Lab Series facility site power for average line voltage, surges, sags, reclosures, impulses, frequency and microcuts. A period that includes two weekends should be used to simulate several days of normal use. Analysis of the data and site history of any previous power problems with other X-ray systems or computer installations should be reviewed with your power and ground representative. Verify "brown-out" (low voltage) conditions, which may occur during summer months, will not exceed the allowable range.

Some analyzer models that are suitable for power monitoring are:

Dranetz Model 658

Dranetz Model 656A

BMI 3630

RPM

Mobile Grounding Requirements

Ground Conductor

An insulated ground conductor is provided in the unit power cord equal in size to the incoming power wires. The customer shall provide an additional grounding rod at the trailer pad. A 50' # 1/0 AWG conductor is provided for the grounding rod mentioned. The conductor terminates in the main panel-grounding terminal. Both grounds protect all devices and components contained within the unit.

NOTE:

The electrical power source must meet the requirements of the national electric code and National Fire Protection Association for Emergency Backup Power as applied to cardiac catheterization labs. Please consult the applicable codes and the local authorities in your area for guidance. The following codes define the requirements of "Emergency Systems" for cardiac catheterization laboratories.

NFPA 70 Article 517-33 (a) (8) c & NFPA99 Paragraph 3-4.2.2.2 (c)

Special Grounding Note

The unit must have an earth driven ground rod within five (5) feet of the hospitable power receptacle. A grounding cable of a minimum 4 GA must be connected between the grounding rod and the grounding pin of the hospital power receptacle, and another cable to be kept as short as possible, and must not exceed 8 feet in length. A separate grounding conductor must still be run with the phase conductors to the source of power from the grounding pin of the hospital power receptacle in accordance with NEC.2002 Article 250-24.

Mobile Grounding Chart

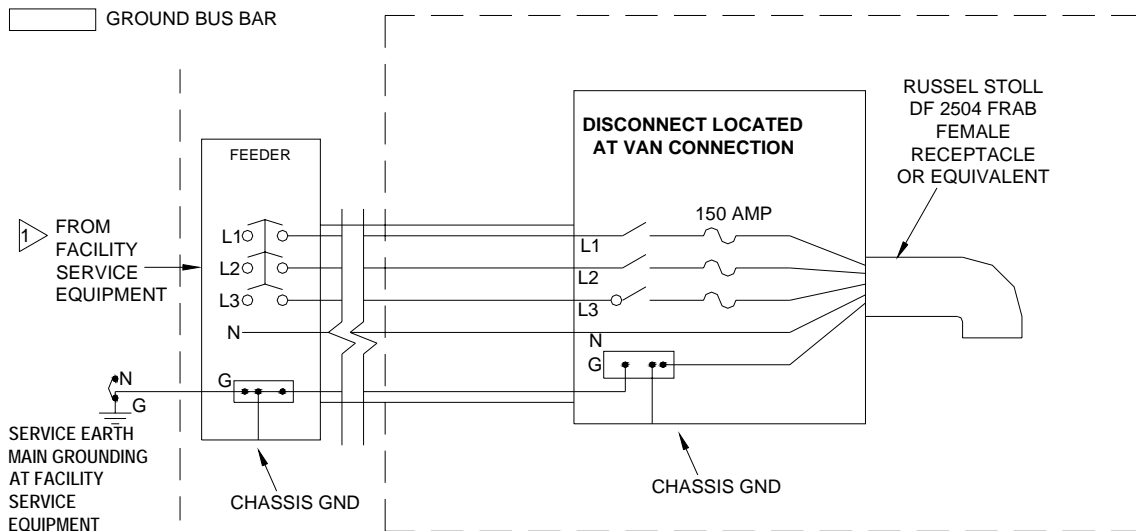
MOBILE GROUNDING REQUIREMENTS

NOTE:

- ALL WORK TO BE DONE IN ACCORDANCE WITH NATIONAL AND LOCAL ELECTRICAL CODES INFORMATION SHOWN HERE IS ONLY A RECOMMENDATION. MUST BE VERIFIED FOR SITE NATIONAL AND LOCAL CODES.

- GROUND WIRES INSIDE ENCLOSURES TO BE TAPED GREEN FOR ENTIRE VISUAL LENGTH FOR IDENTIFICATION.

1 MAIN BONDING JUMPER BETWEEN GROUNDED (NEUTRAL) CONDUCTOR AND EQUIPMENT GROUNDING CONDUCTOR TO BE PROVIDED IN FACILITY SERVICE EQUIPMENT AND DOWNSTREAM AT SEPARATELY DERIVED SYSTEM TRANSFORMER SECONDARY AS SHOWN.



GROUNDING

The ground for our system shall originate at the system power source, i.e., transformer or first access point of power into a facility, and be continuous to our system power disconnect in the room. This ground can be spliced with "High Compression Fittings" and should be terminated at each distribution panel it passes through. When it is broken for a connection to a panel, it shall be connected into an approved grounding block with the incoming and outgoing ground in this same grounding block, which is then connected to the steel panel never using the steel panel never using the steel or other material of the panel as the block

The connection at the power source shall be at the grounding point of the "Neutral-Ground" if a "Wye" transformer is used, or typical grounding points of a separately derived system. In the case of an external facility, it shall be bonded to the facility ground point at the service entrance.

GROUNDING WIRE

The ground wire shall be copper wire with a minimum of AWG 1/0 or the same size as the power feeders whichever is larger. This means that if there is a primary feeder to a distribution panel of 500 MCM with a secondary feeder to our system of AWG 1/0 wire, the ground to the distribution panel shall be 500 MCM with and AWG 1/0 to our system. The ground wire impedance from our system disconnect, including the ground rod shall not have an impedance greater than 2 ohms to earth as measured by one of the applicable techniques described in Section 4 of ANSI/IEEE Standard 142-1982.

Harry E. Rauworth
Debra C. Balis
April 22, 1999

Telephone, Data and Emergency Connections

Telephone Service

The unit is supplied with three telephone connections.

The connector type that is used is a model Hubbell PH-6595 (inlet), supplied by Oshkosh Specialty Vehicles.

Two Hubbell PH-6599 50 foot telephone-connecting cables are included with the unit. If a third cable is needed, the customer must purchase it.

The customer is required to purchase and install three Hubbell phone connectors, model PH-6597 (weatherproof phone outlets) for use at the site.

Data Service

An adapter to connect the medical system is required if a site plans to use existing 10Base2 (coax) Ethernet connections. The adapter will convert between a 10Base2 coaxial connector and a 100BaseT RJ-45 type connector. The mobile unit requires an RJ-45 type connector.

- The unit is supplied with three data line connections.
- The customer is required to purchase the data connection cables. The data connections utilize a 50'-0" CAT-5E cable with an RJ-45 connector.

Code Blue Connections

The unit is supplied with a 35' long cable and male connector for the code blue function. See [Figure 10: Code Blue and Fire Alarm Connections](#) for wiring connections.

The connector is a Russellstoll #SKWP8G.

The facility must have the matching female receptacle Russellstoll #SKWP8G.

Fire Alarm Connections

The unit is supplied with a 35' long cable and male connector for the fire alarm function. See [Figure 10: Code Blue and Fire Alarm Connections](#) for wiring connections.

The connector is a Russellstoll #SKWP8G.

The facility must have the matching female receptacle Russellstoll #SKWP8G.

Water Requirements

A potable water connection and wastewater drainage provision are required for the catheterization laboratory.

Humidifier Water Fill

The unit contains a water storage tank for the humidifier. This tank is located in the equipment room and must always contain water to insure the specified humidity level remains constant. There are two options for filling the tank:

A $\frac{3}{4}$ " male threaded garden hose connection is located under the equipment room.

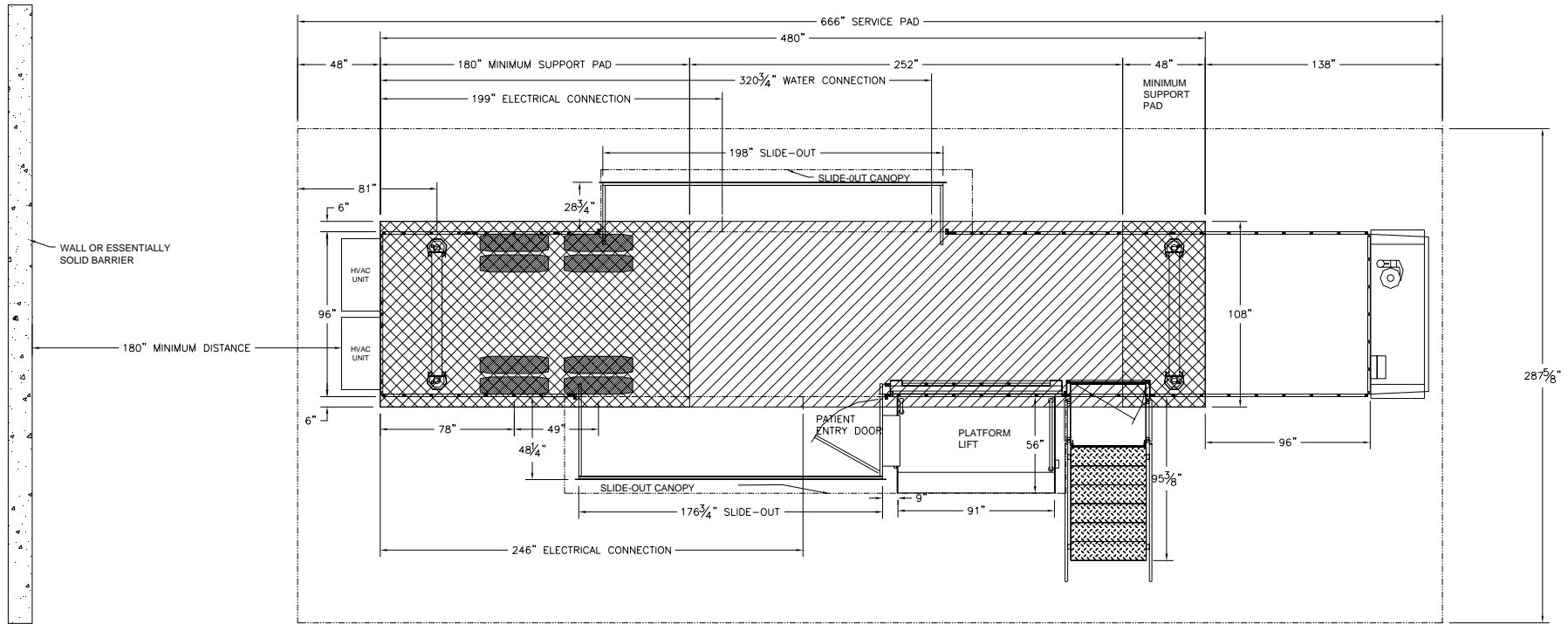
A fill port is located in the humidifier for manual fill capability.

Potable Water Supply Requirements

A cold water supply line is required, with a flow rate of 5 gallons/minute, 45-60 psi and a maximum temperature of 70°F. The unit will be supplied with a $\frac{3}{4}$ " diameter, 20' long hose terminated with a $\frac{3}{4}$ " I.P.S. male threaded hose connector. The facility is to provide a $\frac{3}{4}$ " female connector to connect to the units 20' long hose.

Waste Water Connections

The unit is supplied with a $\frac{3}{4}$ " diameter I.P.S. male threaded hose connector to accommodate drainage. The facility must provide means of sanitary wastewater drainage from the system that comply with locally applicable codes.



NOTE: IF TWO UNITS ARE PARKED BACK TO BACK,
A MINIMUM DISTANCE OF 20' MUST BE
MAINTAINED FROM COIL GRILL TO COIL
GRILL OF THE A/C UNITS.

Figure 1: Pad Layout

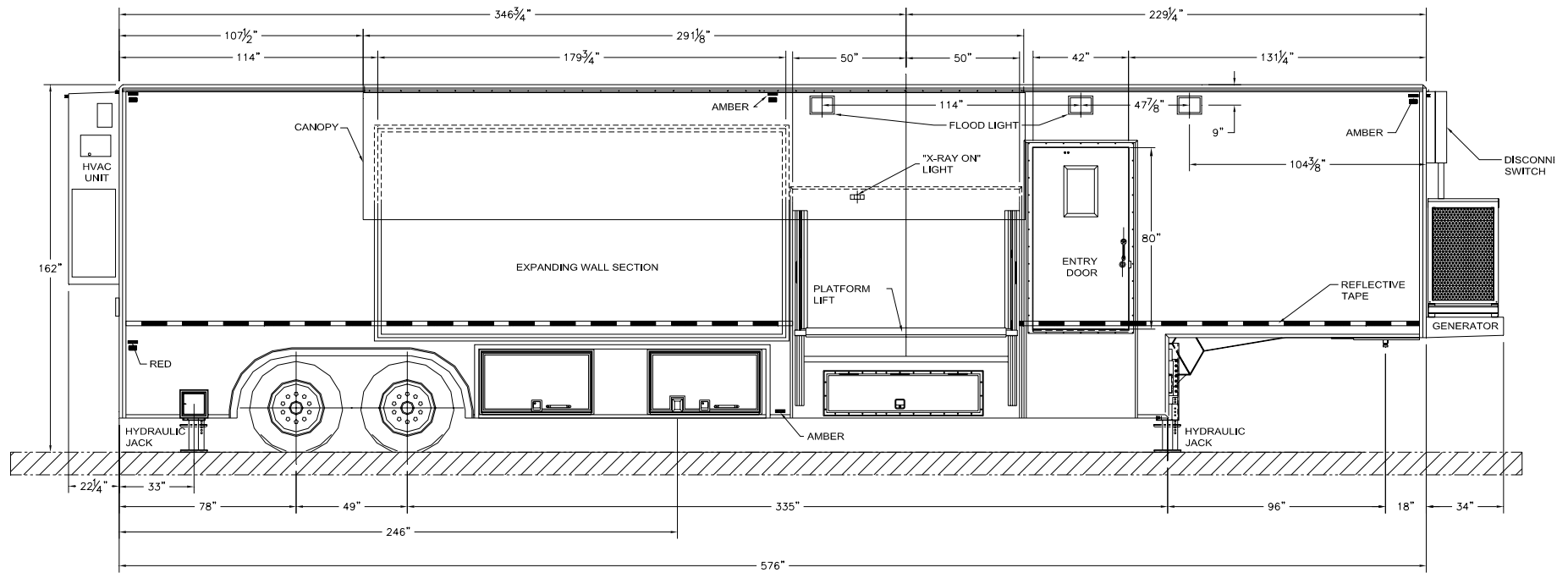


Figure 2: Right Side Elevation

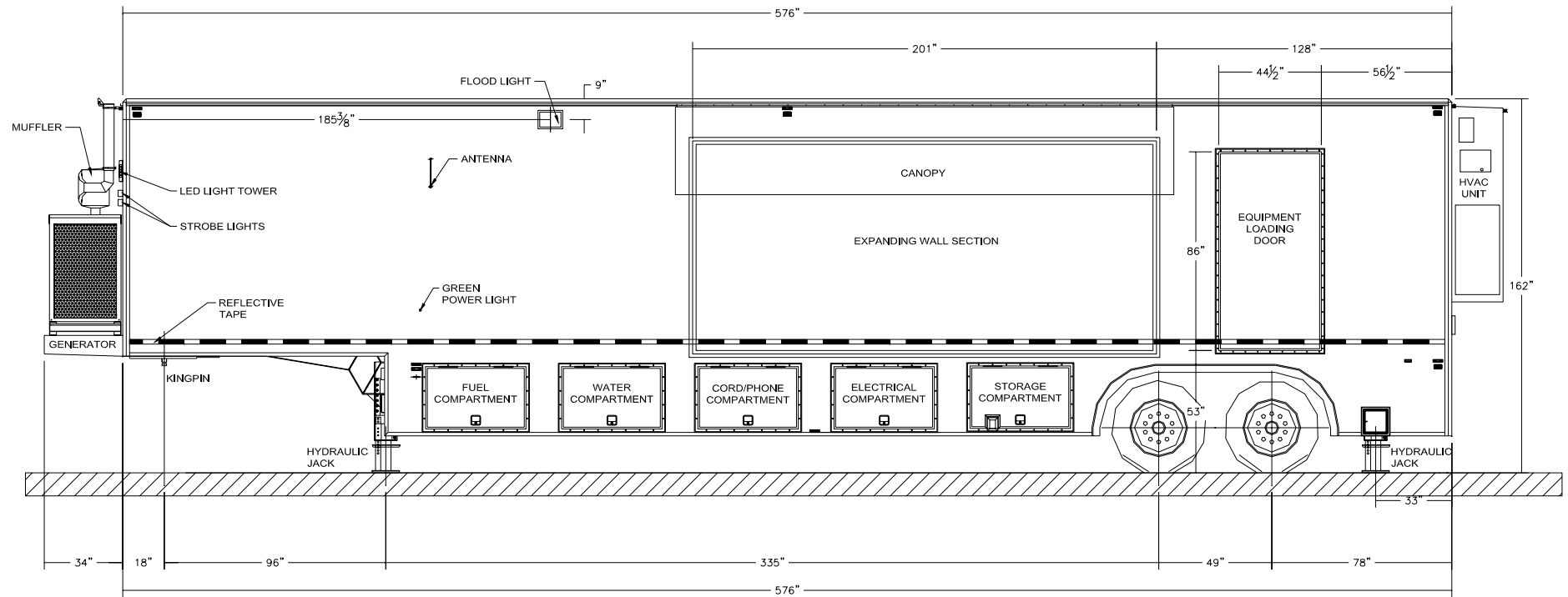


Figure 3: Left Side Elevation

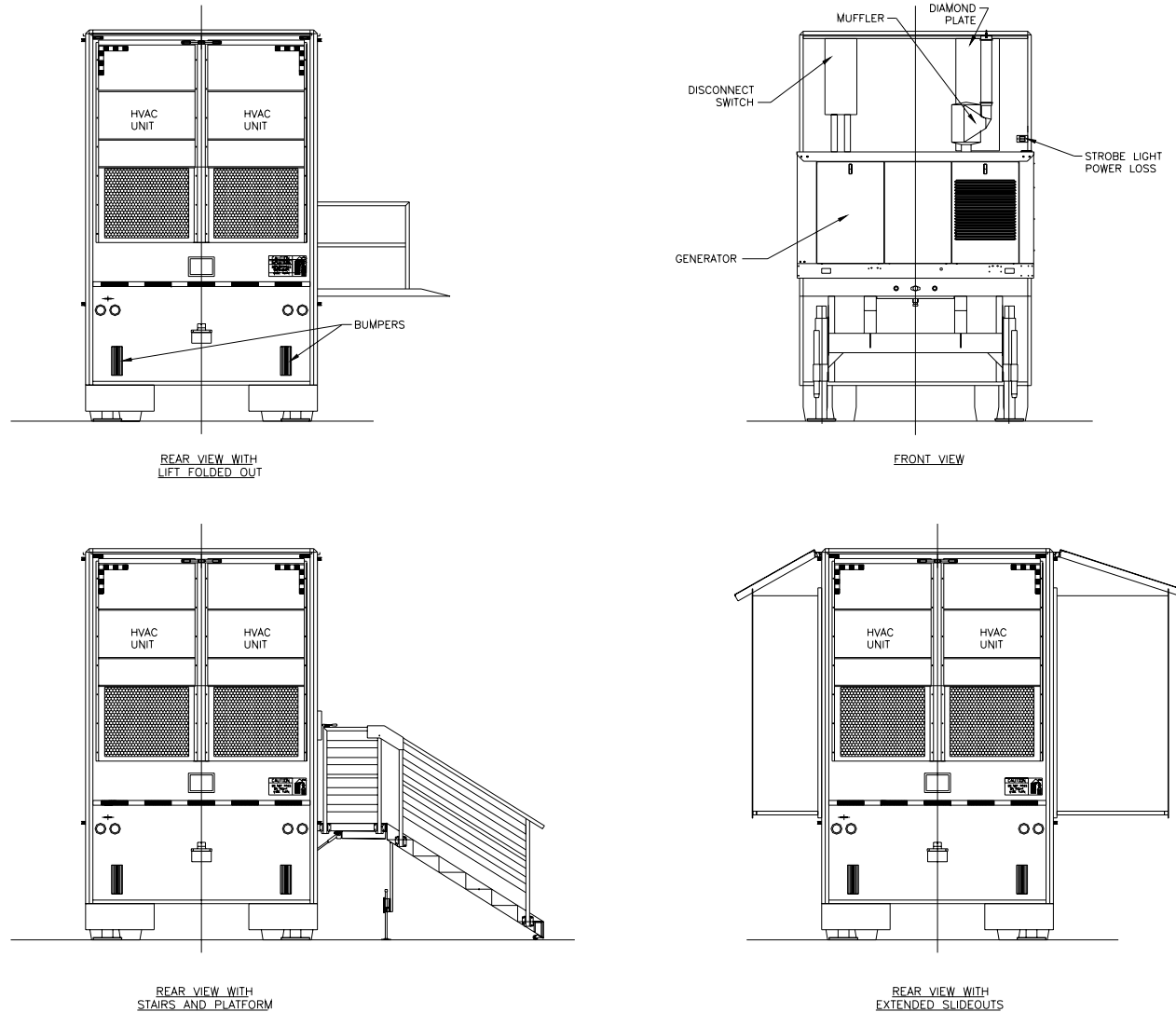
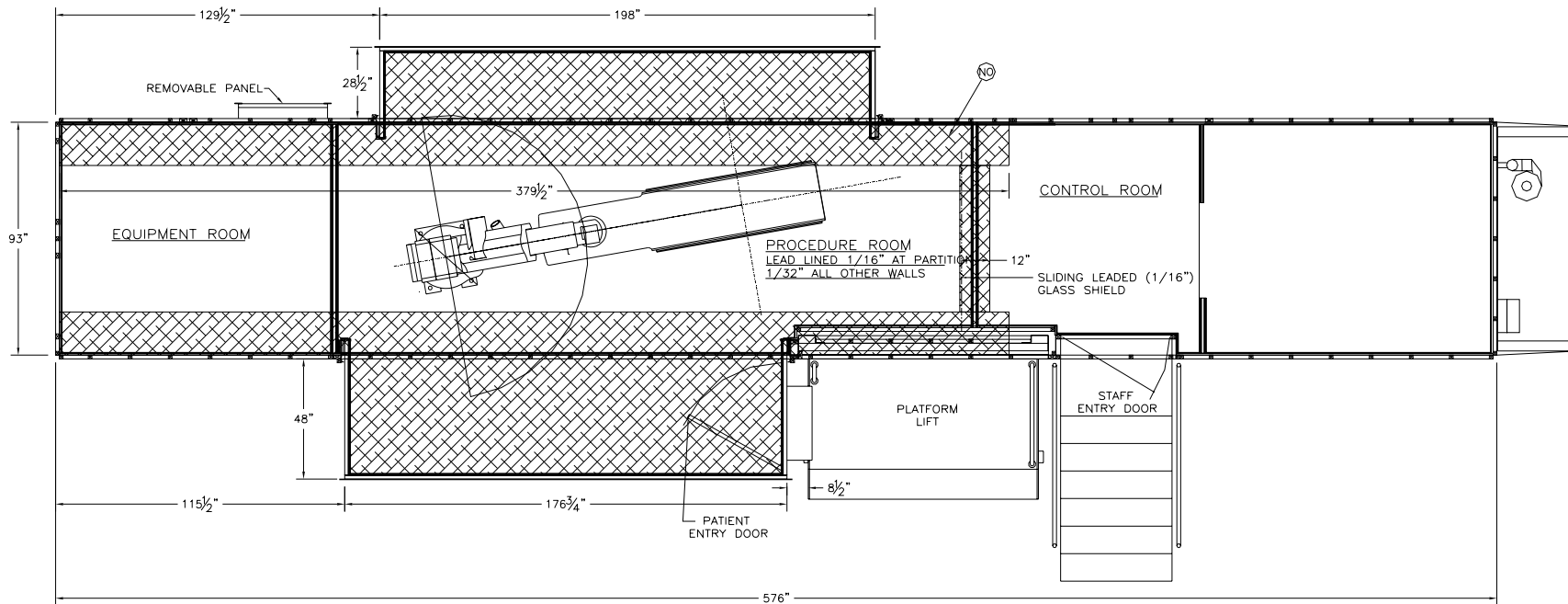


Figure 4: Stair / Lift / Wall Elevation



NOTE:
PROVIDE 1" OF LEAD TO FOLD
UP ON ALL EXTERIOR WALLS
EXCLUDING SLIDE-OUT WALLS

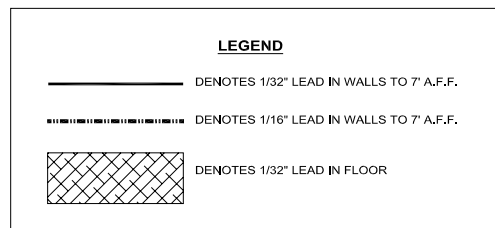


Figure 5: Radiation Shielding Plan View

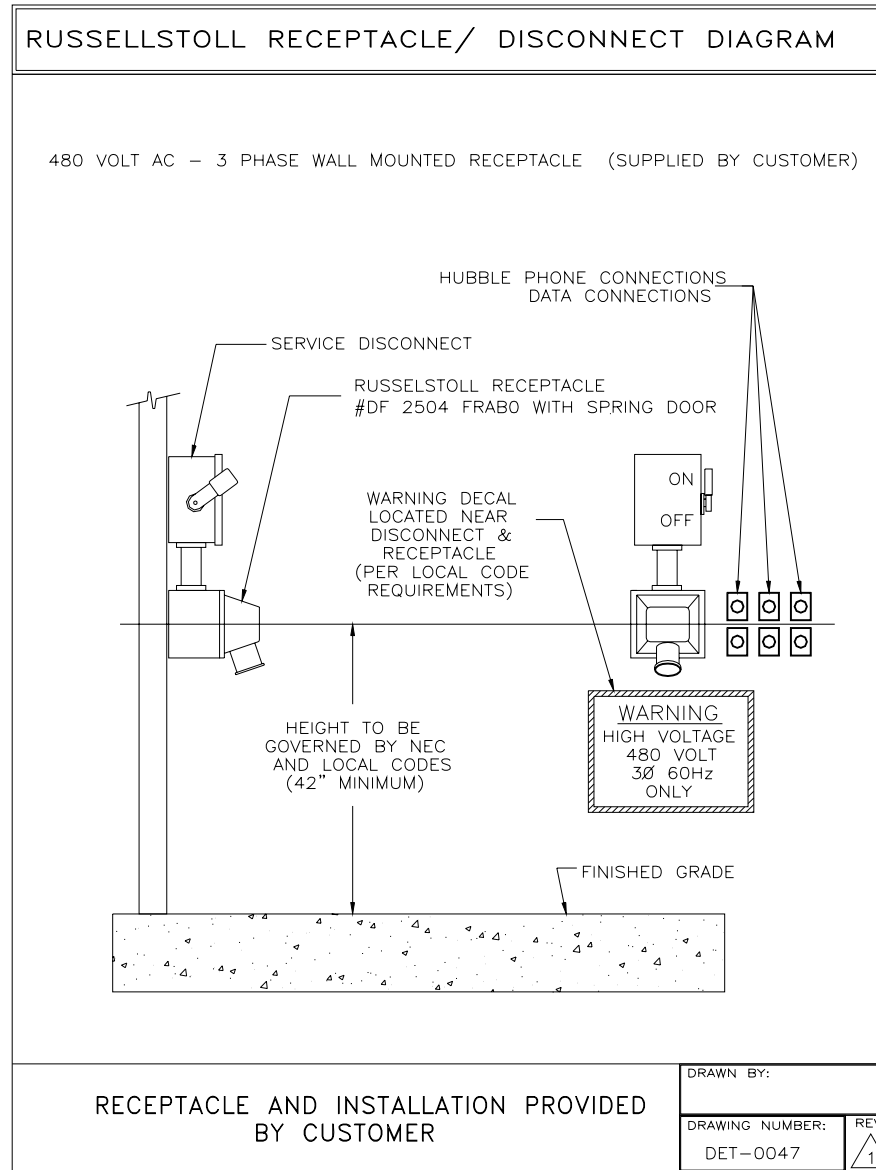


Figure 6: Russellstoll Service Outlet

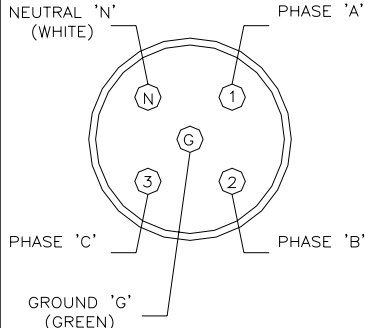
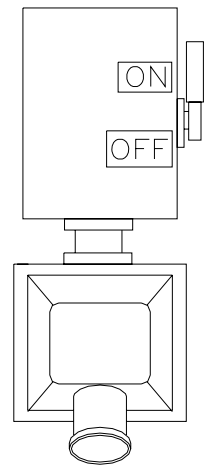
RUSSELLSTOLL RECEPTACLE CHART			
AMP / WIRE	DESCRIPTION		RECEPTACLE
	WIRES	POLES	PART NUMBER
MAXIMUM WIRE SIZE FOR LUG # 1/0	5	4	480 VOLT (200 AMP) 5 WIRE RUSSELLSTOLL RECEPTACLE DF 2504 FRABO THIS RECEPTACLE MUST BE WATERPROOF
480 VOLT AC DEDICATED POWER LINE FROM MAIN TRANSFORMER STATION	3Ø	WYE CONNECTION 150 AMP TOTAL 3Ø NEUTRAL AND GROUND	
RUSSELLSTOLL MATING PLUG PART# DS2504MP000/DF2032 5 WIRE/4 POLE		MAIN DISCONNECT 3/N/PE AC 480 VOLT 150 AMP FUSED DISCONNECT	
			
RECEPTACLE AND INSTALLATION PROVIDED BY CUSTOMER			DRAWN BY: DRAWING NUMBER: DET-0048 REV 2

Figure 7: Russellstoll Chart

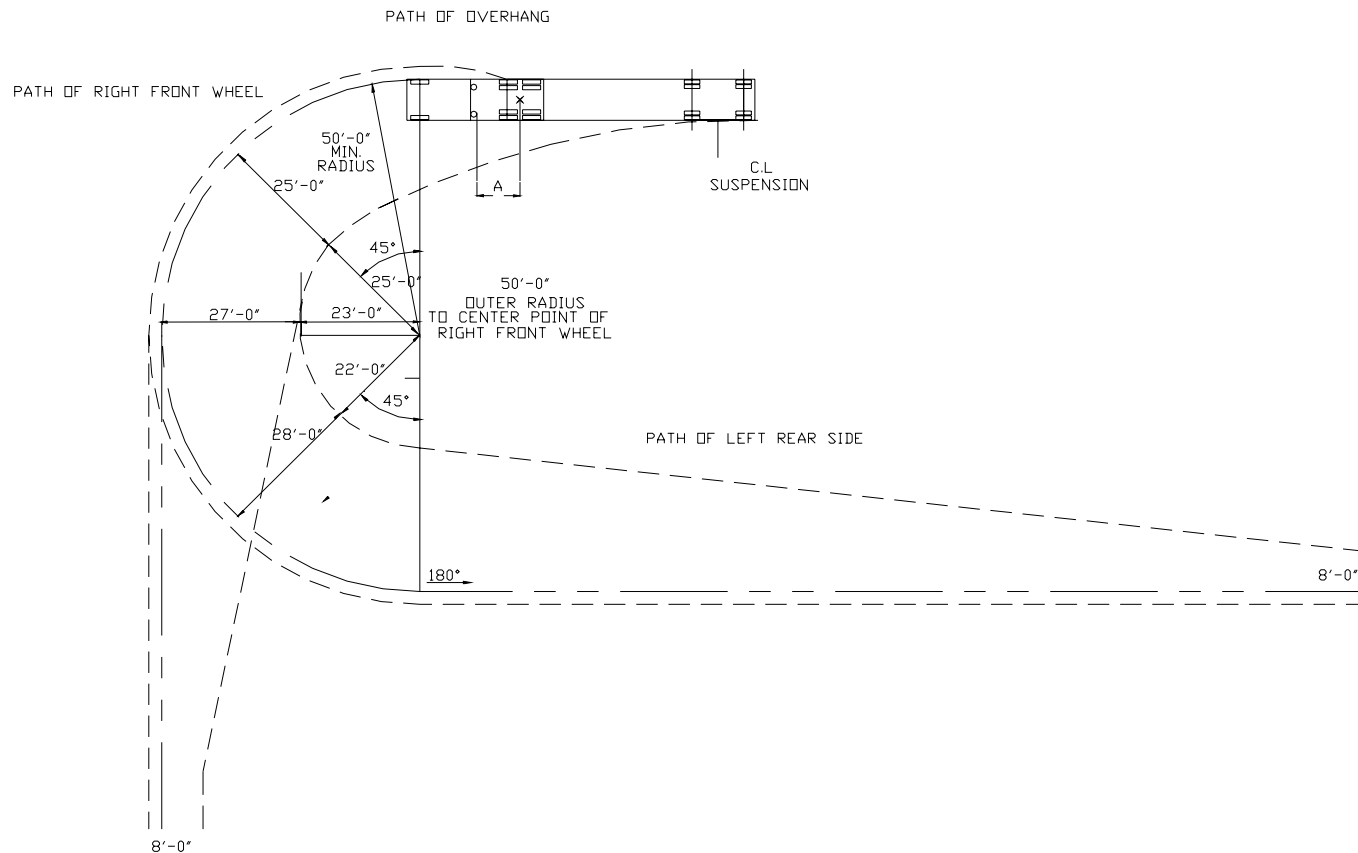


Figure 8: Turning Requirements

A minimum dimension of 86" is required from rearmost projection to centerline of tandem suspension. This provides swing clearance for generator set which is mounted on the front of the trailer. Hospital is responsible to ensure the access route is clear of obstructions when the trailer is scheduled to arrive or depart. The 50' minimum outside turning radius shown here has been calculated using an international harvester (Navistar) tractor Model COF-9670 with a 161" wheelbase. Turning radius will vary with towing tractor. Customer must confirm the turning radius on their tractor and prepare each site with adequate space to accommodate it.

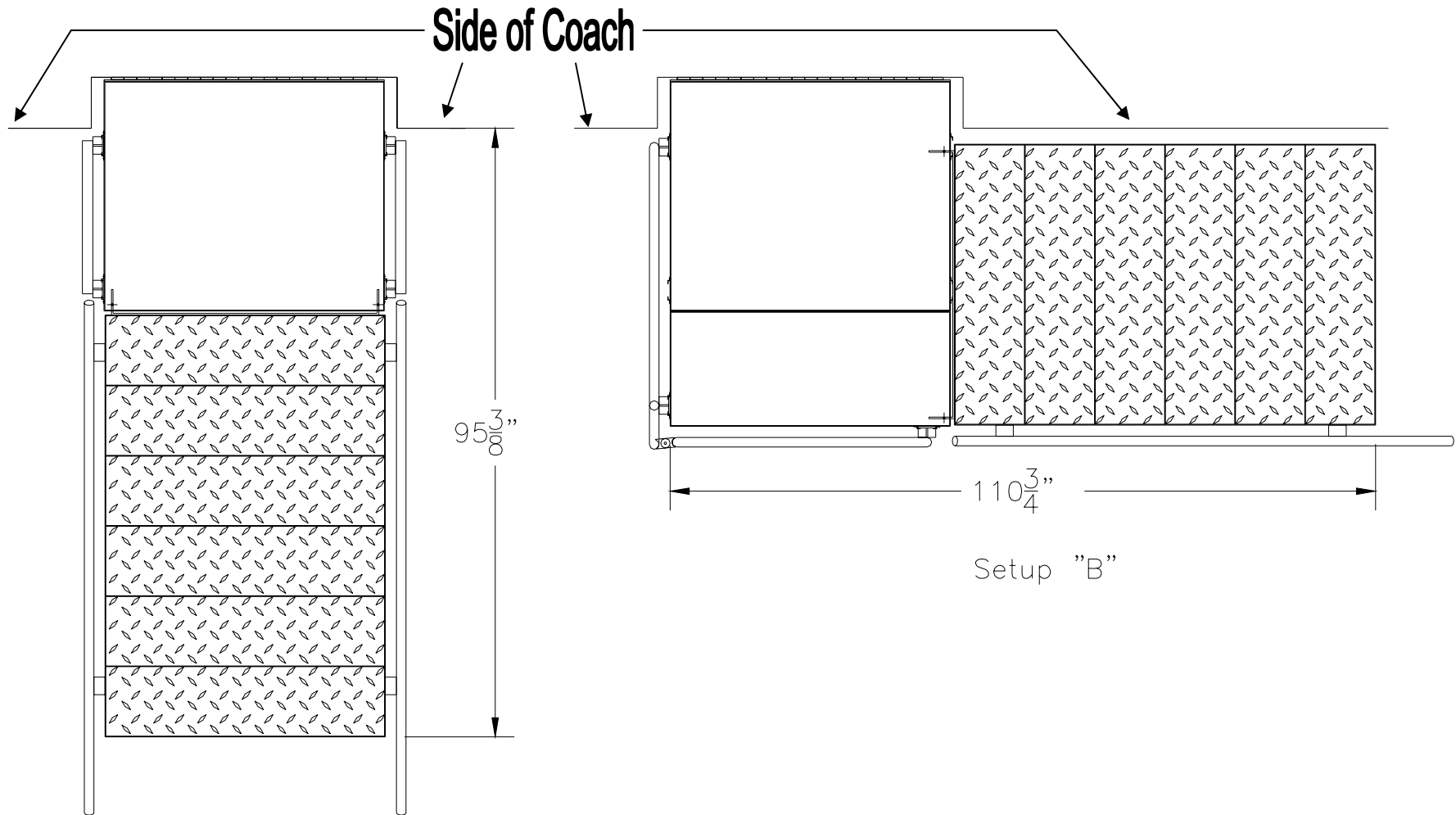
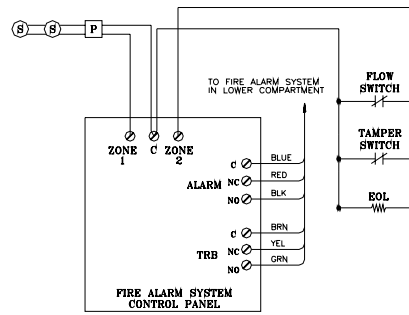
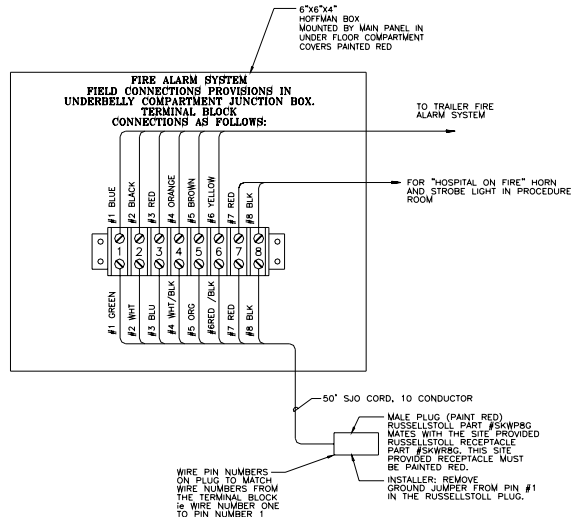


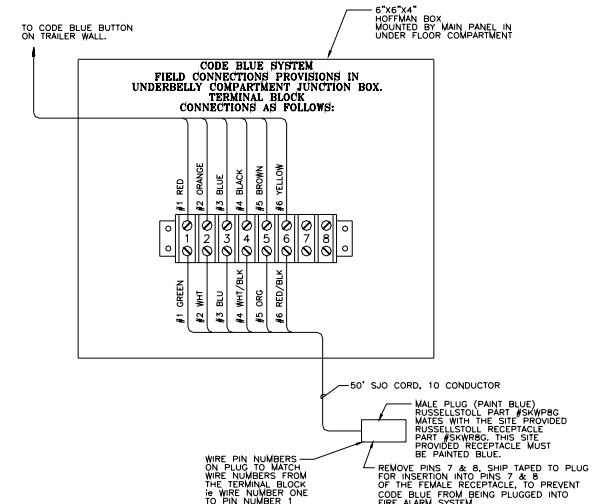
Figure 9: Variations of Stair Arrangement



CODE BLUE & FIRE ALARM FOR MOBILE CARDIAC CATH LAB



(OPTIONAL)
WET FIRE SUPPRESSION WIRING DIAGRAM



TB#	DESCRIPTION	FUNCTION	CONTACTS	WIRE COLORS
1	CODE BLUE SYSTEM	LIGHT	---	RED
2	CODE BLUE SYSTEM	LIGHT	---	ORANGE
3	CODE BLUE SYSTEM		NO	BLUE
4	CODE BLUE SYSTEM		NO	BLACK
5	CODE BLUE SYSTEM		NC	BROWN
6	CODE BLUE SYSTEM		NC	YELLOW

CODE BLUE BUTTON WIRING

TB#	DESCRIPTION	FUNCTION	CONTACTS	WIRE COLORS
1	FIRE ALARM SYSTEM	ALARM	NC	BLUE
2	FIRE ALARM SYSTEM	ALARM	COM	BLACK
3	FIRE ALARM SYSTEM	ALARM	NO	RED
4	FIRE ALARM SYSTEM	TROUBLE INDICATION	NC	ORANGE
5	FIRE ALARM SYSTEM	TROUBLE INDICATION	COM	BROWN
6	FIRE ALARM SYSTEM	TROUBLE INDICATION	NO	YELLOW
7	+24V ALARM RELAY FROM FACILITY			RED
8	-24V ALARM RELAY FROM FACILITY			BLK

ALL DRY CONTACTS RATED 24VOLT 1.0AMPERE (CLASS II WIRING)

Figure 10: Code Blue and Fire Alarm Connections